

GENERAL

	PAPAYA 3D	PAPAYA 3D PLUS	
Exposure Time	Panoramic	9 ~ 17 sec	9 ~ 17 sec
	Cephalometric	—	4 ~ 12 sec
	CT	7.7/14.5 sec	7.7/14.5 sec
FOV	Φ35 x 40mm ~ Φ140 x 140mm (19 programs available)		
Voxel Size	75~400 μm adjustable		
Focal Spot	0.5mm		
Target Angle	5°		
Tube Voltage	60 ~ 90kV		
Tube Current	4~12 mA		
Line Voltage	220V, 50/60Hz		

SENSOR

	CT	Panoramic	Cephalometric
Pixel Pitch	100 x 100 μm	75 x 75 μm	75 x 75 μm
Active Area	130.2 x 128 mm	152 x 6.45 mm	228 x 6.45 mm

* The specifications above can be changed to improve performance without notice.

Dimensions

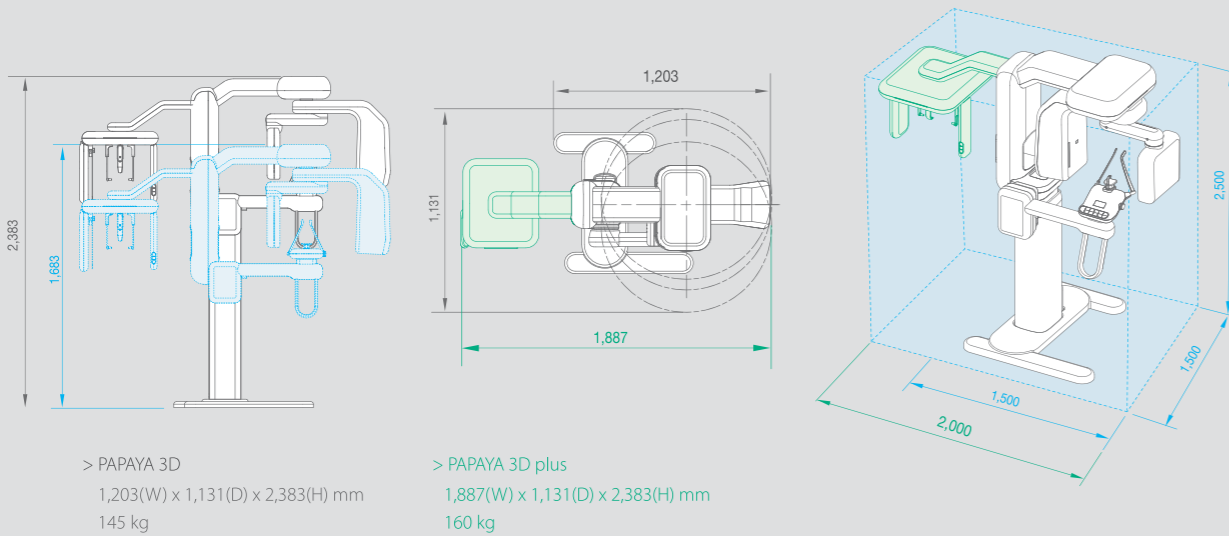

Choose your own PAPAYA Serie

	PAPAYA	PAPAYA PLUS	PAPAYA 3D	PAPAYA 3D PLUS
Panoramic	●	●	●	●
3D Imaging			●	●
CUST Imaging	●	●		
Cephalometric		●		●

GENORAY Co.,Ltd.
512, 560, Dunchon-daero, Jungwon-gu, Seongnam-si,
Gyeonggi-do, 462-716, Korea
Tel. +82-31-627-3900 Fax. +82-31-737-8016
genoray@genoray.com

www.genoray.com

Genoray America Inc.
147 E. Bristol Lane Orange, CA 92865 USA

Genoray EU GmbH
Westhafenstr. 1 13353 Berlin, Germany

Genoray Japan
2F Ishibashi-Bldg, 1-4-15 Shinyokohama,
Kouhoku-ku, Yokohama-city, kanagawa, 222-0033 Japan



© 2017 GENORAY Co., Ltd. Ver. 01 201701 1/4

PAPAYA 3D PLUS

Combination Dental X-ray Imaging System



3D CT / Panoramic / Cephalometric



Combines

3D CT, Panoramic, Cephalometric

The versatile imaging capability provides the user with accurate information for implant planning.

- Multi-FOV Selection
- 7.7 sec Fast Scan for 3D image
- Dedicated sensor for each mode
- Safety, stability, durability



Automated sensor switching for each scanning mode.

Auto-switching system positions the appropriate sensor without manual intervention.

The structure is optimized for safety, stability, and durability.

Balance and rigidity prevents position errors during scan
Stability reduces installation requirements

All axis motorized movement

(UP/DOWN/LEFT/RIGHT).



The remote activation control includes an emergency stop button



Convenient storage tray for patient's articles during examination.



Face to face layout assists in accurate patient positioning



Voice prompting for patient guidance and re-assurance.



Hand Grip



Wheelchair access

3D CT

High Resolution Computed Tomography Technology

Clearly defined images in three dimensions provide users with accurate diagnostic information.



Fast scan mode

Scanning times of as low as 7.7 seconds reduce dose, motion artifacts and image distortion.

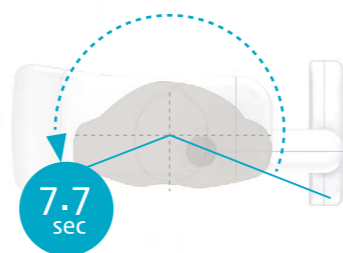

Auto-stitching technology

The wide high definition images can be enhanced by auto-stitching technology



Dedicated sensor for CT

A separate sensor, optimised for CT imaging ensures the best results.

Multi-FOV Selection

Multi-F.O.V. selection enables accurate scanning whilst keeping dose levels to a minimum.



Endo	Teeth	Jaw	Face <small>* Optional</small>
Endodontic	High Resolution High Definition	Normal Resolution	Low Dose
Endo mode shows high definition images	High contrast images of upper / lower jaw enable accurate diagnosis.	Provides an image of the full arch.	full arch including relevant bone areas



Φ 4x5



Φ 8x8



Φ 16x8



Φ 16x14

Panoramic

High Resolution Panoramic Technology

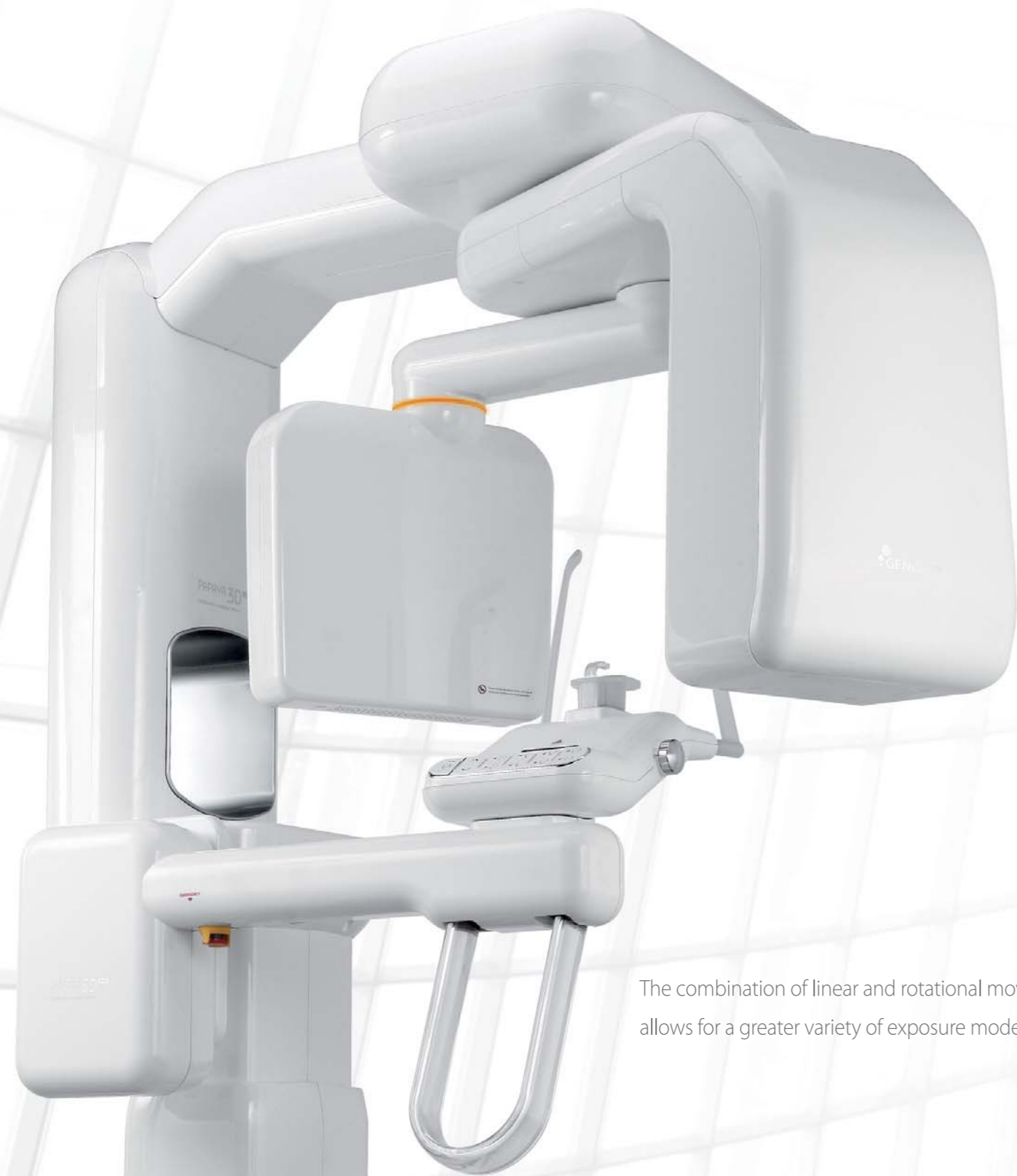

The combination of linear and rotational movement allows for a greater variety of exposure modes.

Exposure Programs

PAPAYA 3D PLUS supports various exposure programs, fulfill all diagnostic needs. Standard panoramic, orthogonal panoramic, bitewing panoramic, child panoramic, TMJ lateral double, horizontal & vertical X-ray segmentation, **TMJ PA double**, **TMJ LAT-PA**, **TMJ LAT-PA double**, sinus lateral and sinus PA are supported.



Standard panoramic



Orthogonal panoramic

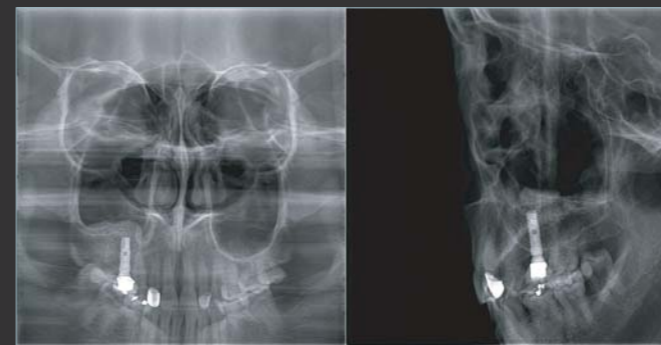

Sinus PA / Sinus lateral midsagittal



X-ray segment



Bitewing



TMJ lateral double

Cephalometric

High Resolution Cephalometric Technology



- The optimized mechanical structure is designed for symmetrical balance, enhanced safety and durability.
- To optimise result, the sensor automatically positions for each exposure mode
- Only 4 seconds for scanning a cephalo image in fast mode. This reduces motion artifacts.

Exposure Programs

PAPAYA 3D PLUS supports various exposure programs to fulfill all diagnostic needs. Lateral, AP, PA, Water's view, Submento vertex, and carpus, are supported.



Lateral



AP



Water's view



Submento vertex



Carpus

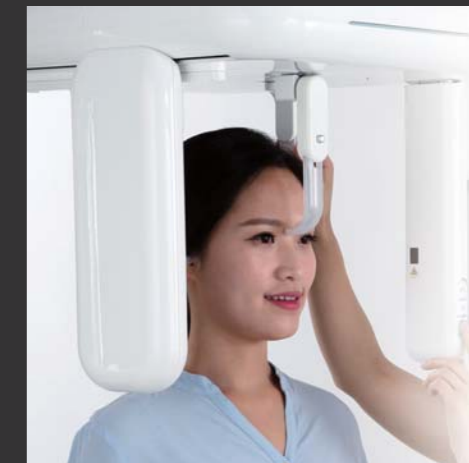

PAPAYA 3D operation software



Panoramic exposure mode

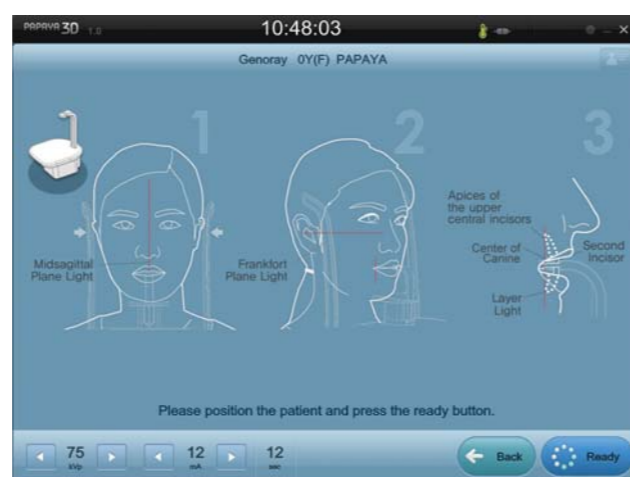

Patient positioning guide



Cephalo exposure mode



CT exposure position (Adult)

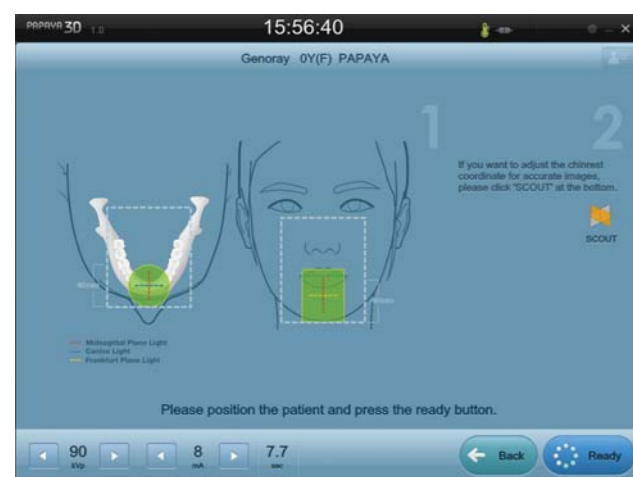

Positioning guide for CT patient (Full scan)

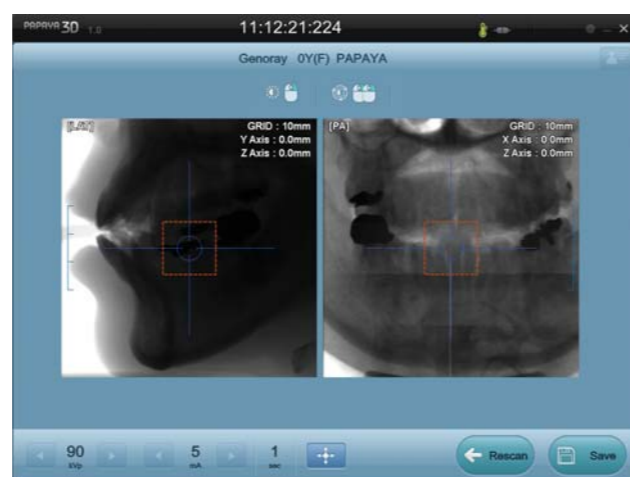

SCOUT image screen

TRIANA Genoray 3D image viewer

Clearly defined images in three dimensions provide users with accurate diagnostic information.

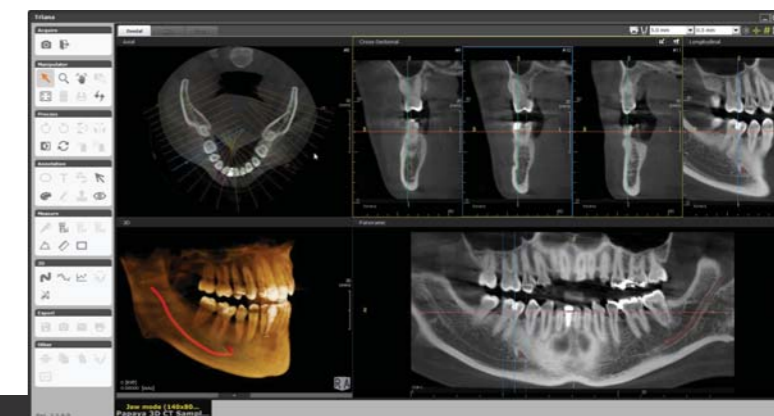

3D Volume Rendering

Various volume rendering options such as Gray, X-ray, MIP and etc provide 3D image visualization

MPR (Multi-Planar Formatting)

MPR mode provides three plain view (axial, coronal and sagittal) on one screen for focused area diagnosis.

Dental Reformatting

Using panoramic, cross-sectional, and longitudinal 2D view, you can plan your 'perfect' implant positioning

Curved MPR

Possible to reconstruct the sectional images which is via any curves from Panoramic, Cross-sectional, Longitudinal

Image Color-mapping

Color mapping increases the visibility of lesions

CDSee

CDSee generates an external output on CD, DVD or USB storage of 3D volume data with free version of Triana.

Dental Crop

Able to create Intra-Oral X-ray FMX images in panoramic images.

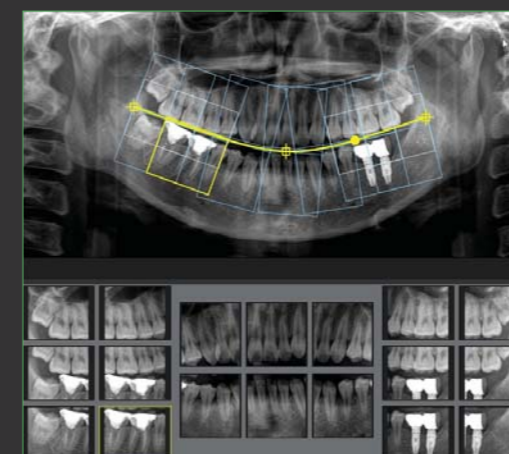

Measuring tools

Distance, Angle, Profile, and arrow provides easy to use measuring tools.

Implant planning

Multiple layout support and nerve implementation enables accurate implant planning.

Support for DICOM 3.0

STL Export

3D images can be divided freely and converted into STL data to enable 3D printer and CAD/CAM Software to be used.

